

# Ultrasonic Flow Meter

Clamp On Type- Small Pipe Size Solution



## Product Introduction





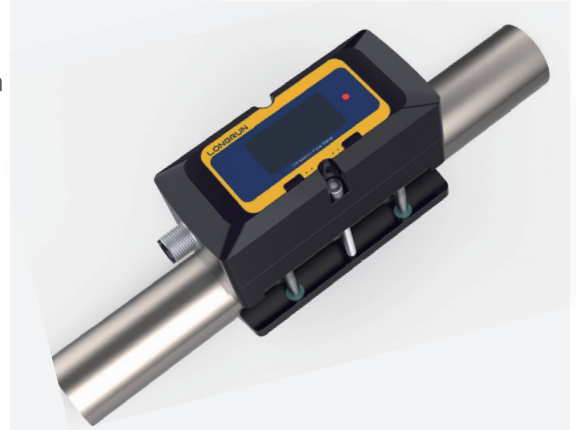

It is an integrated type transfer time ultrasonic flow meter with the clamp on type transducers. It is compact and very easy to install, making it suitable for flow process monitoring application involving various small pipe size. It is also another good choice for the devices process equipment liquid monitoring.

- Does not require the measured liquid to be conductive.
- Installation does not necessitate pipe cutting or process shutdowns, allowing operation to continue uninterrupted. There are no moving parts and no pressure loss.
- Installation could be performed without specialized training, just by an instructional video or step by step diagram.
- The enclosure is made of PP and fiberglass, ensuring durability in acidic or alkaline environment.

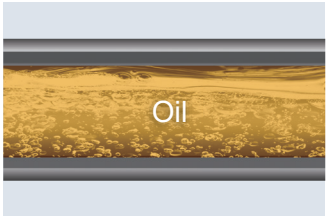
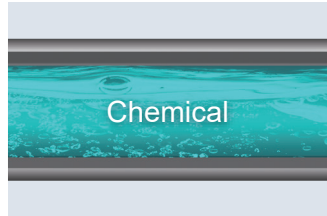
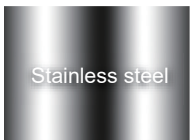

Adaptable different liquid types and pipe materials:

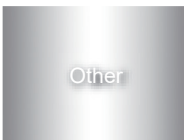
(Common examples, if not listed, please contact the factory for confirmation)

<p><b>1</b> Applicable fluid</p>	 <p>Water</p>	 <p>Oil</p>	 <p>Chemical</p>		
<p><b>2</b> Compatible piping material</p>	<p>Metal pipe Stainless steel, Carbon steel, Copper</p>		<p>Resin pipe PVC, Other</p>		
	 <p>Stainless steel</p>	 <p>Carbon steel</p>	 <p>Copper</p>	 <p>PVC</p>	 <p>Other</p>
<p><b>3</b> Compatible pipe line size</p>	<p>DN10-D40            ((If you have the application for a pipe size DN8, please contact the factory for confirmation))</p> 				

# F7 Flow Watch

Provide many aspects of help for different flow measurement application requirements:



**1**  
Site display

Monitor the flow rate reading directly on the device.

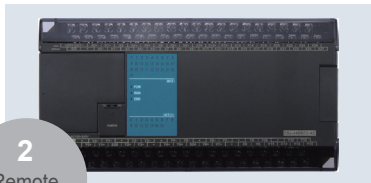

**2**  
Remote monitoring

With the help of output, could send the information to PLC, central control room and etc.



**3**  
Data analysis

Record the data to improve efficiency.

## Specification

Enclosure material	PP and F		
Mounting screw	SS304		
Enclosure protection class	IP54		
Vibration resistance	10 to 55 Hz, double amplitude 1.5 mm, 2 hours in each XYZ axis		
Impact resistant	100 m/s <sup>2</sup> 16 ms pulse, 1000 times each for X, Y and Z axis		
Models	DN10、DN15、DN20、DN25、DN32、DN40		
Flow range	DN10	DN15	DN20
	1 - 30 LPM	2 - 60 LPM	3 - 100 LPM
	DN25	DN32	DN40
	5 - 150 LPM	8 - 260 LPM	12 - 400 LPM
Pipe material	Metal /PVC, PP, PE or PVDF rigid plastic pipe (Common examples, if not listed, please contact the factory for confirmation)		
Medium	Water, Alcohol, Liquid gasoline, Chemical solvent and other fixed composition liquid other liquid (Single liquid medium without solid particles or impurities) /Common examples, if not listed, please contact the factory for confirmation		
Medium temperature	Standard :-10°C - 65°C Middle temperature transducers: -10°C - 105°C		
Accuracy	< 2% FS.		
Response time	0.5s-3s		
Power supply	20-28VDC≥1A		
Electric power	1W		
Power and I/O connection	M12-A type aviation plug (Five-cores)		
Output	4-20mA		
Communication	RS485 Modbus		
Display	1.5' Oled display		
Keyboard	2 touch buttons		
Environment temperature	-10°C - 60°C (No freezing)		

## Connection/ Wiring

### Connection/ Wiring type :

M12-A type aviation plug (Five-cores)

### Connection/wiring definition

Color	Definition	Mark
Brown	24VDC 1A	Power in +
Black	Flow 4-20mA OUT	4-20mA OUT +
Blue	0V	Power in -/ 4-20mA OUT -
White	A	RS485
Grey	B	

### Wiring diagram

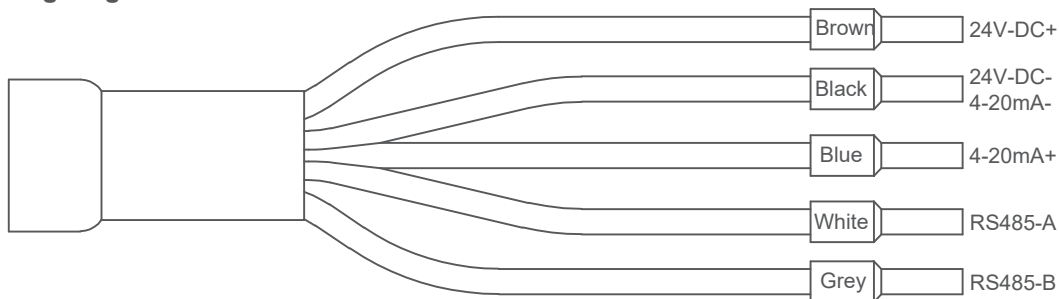

## Installation Settings







Easy to install

With just two steps of setting, you could make an installation and power on for use. No need make any movements to do the adjustable.

### 1、Menu: OD setting

Setting		
OD.	a 12.0	mm
THK.	c 1.0	mm
FI.	0. Water	

The outer diameter parameters supported by each specification are as follows:

Pipe size	OD(mm)	Flow range	illustration
DN8	Please contact the factory for confirmation		
DN10	Ø12mm-Ø18mm	1 - 30 LPM	
DN15	Ø18mm-Ø23mm	2 - 60 LPM	
DN20	Ø23mm-Ø28mm	3 - 100 LPM	
DN25	Ø28mm-Ø33mm	5 - 150 LPM	
DN32	Ø33mm-Ø44mm	8 - 260 LPM	
DN40	Ø44mm-Ø52mm	12 - 400 LPM	

### 2、Menu: wall thickness setting

Setting		
OD.	a 13.0	mm
THK.	c 1.0	mm
FI.	0. Water	

specification are as follows:

DN10-DN40	1.0mm、1.5mm、2.0mm、2.5mm、3.0mm、 3.5mm、4.0mm、4.5mm、5.0mm、5.5mm
-----------	---

For each specification product and each application, please setting the pipe wall thickness according to the site information value. After setting, the inner diameter should not be lower than the lower limit of the specification.

Take DN10 as an example, after setting the outer diameter and wall thickness, the inner diameter value should not be less than 10mm.

## Size Drawing (Unit: mm)

### DN10-DN25

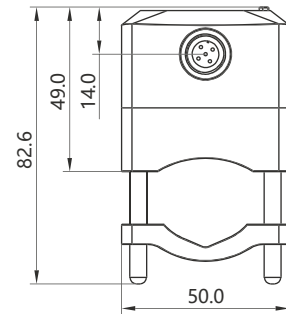
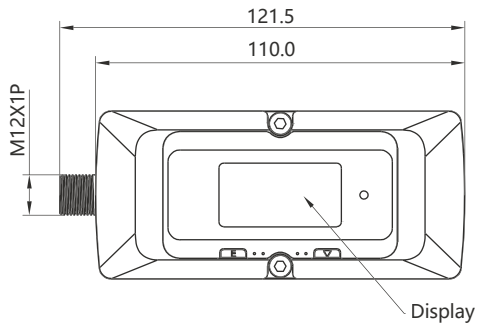

### DN32-DN40

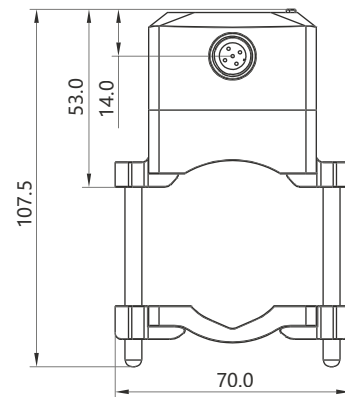
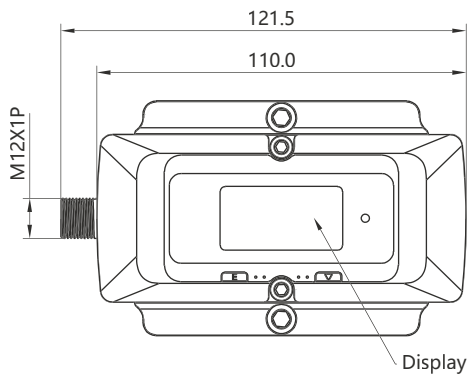

## Ordering confirmation

Model	
F7	Pipe size: DN10-DN40
	Velocity : 0.15m/s-10m/s;
	Accuracy : < 2% FS (< 1.5% FS after calibration )
	Medium: water/ single medium liquid without solid impurities
	Power supply: 20-28VDC/≥1A
	Transducer temperature range: -10~65°C or -10~105°C
	Cable length: 2m
	Pipe size
10A	DN10 OD 12-18mm
15A	DN15 OD 18-23mm
20A	DN20 OD 23-28mm
25A	DN25 OD 28-33mm
32A	DN32 OD 33-44mm
40A	DN40 OD 44-52mm
DN8	Please contact the factory
	Temperature Range
TT02S	-10-65°C
TT03S	-10-105°C
	Options
T	Display and measure the liquid temperature

### Example

20A

DN20 (OD 23-28mm) Clamp on ultrasonic flow meter, transducer temperature range -10-65 °C, 24VDC power supply with 4-20mA and RS485(Modbus) output, cable length 2m.