

Energy Watch Instruction Manual

Model:E5

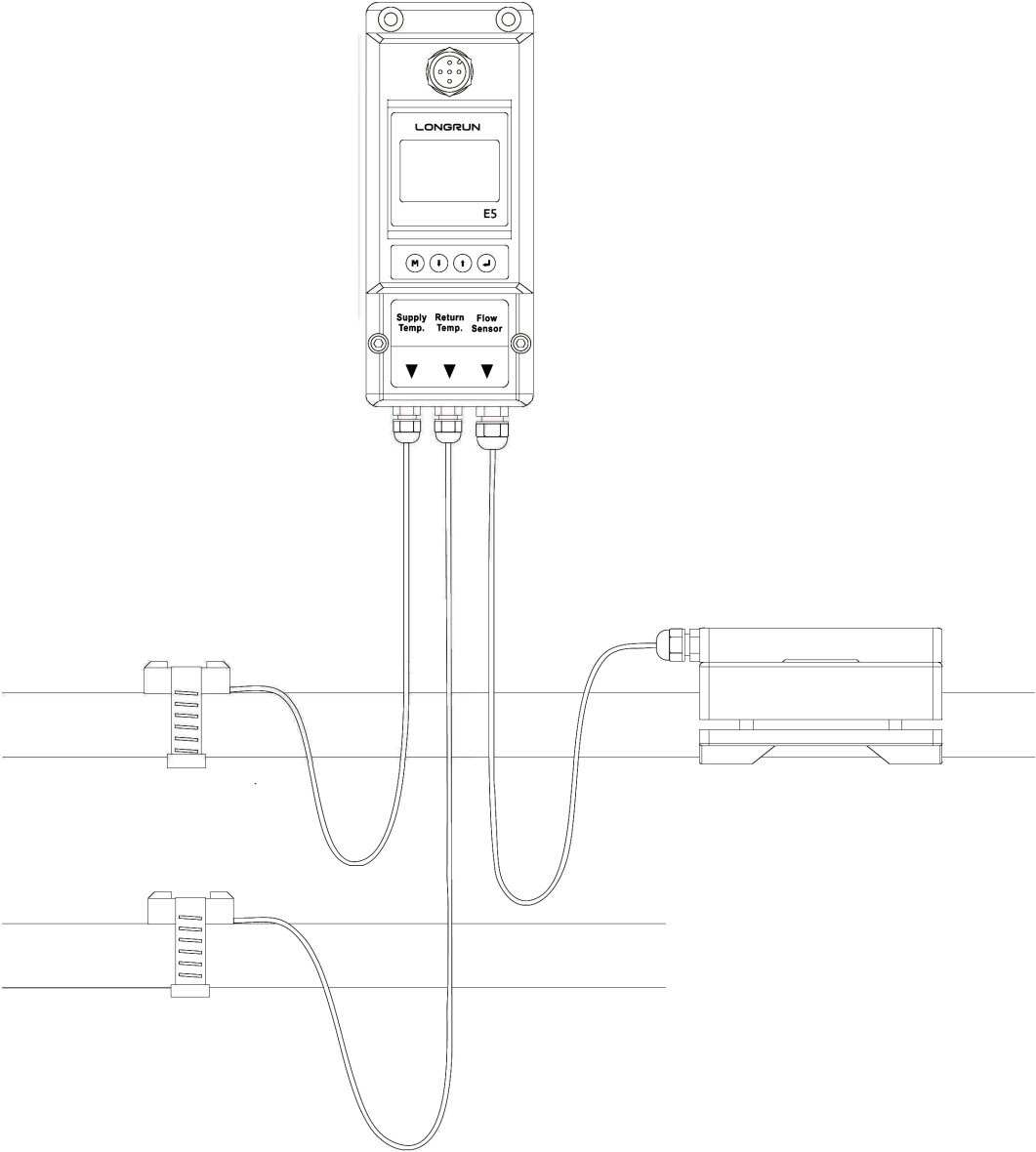

LONGRUN

Content

1.Product components.....	1
2.Installation and connection.....	2
3.Panel function.....	3
4.Powering on.....	3
5.Keypad functions.....	3
6.Window descriptions.....	4
7.Dimensions.....	10

Notice

Thank you for choosing Model E5 Energy Watch.
This instruction manual contains the important using and operation information of the flow meter. Please read carefully the reference manual before operation to make your flow meter exert the best performance.

If you make a mistake ,it will affect the meter's normal working and reduce the meter's life or cause some malfunctions.

Product components

Inspection should be made before installing the Flow meter. Check to see if the spare parts are in accordance with the packing list. Make sure that there is no potential damage to the enclosure due to a loose screw or loose wire, which occurred during transportation. Any questions, please contact your representative as soon as possible.

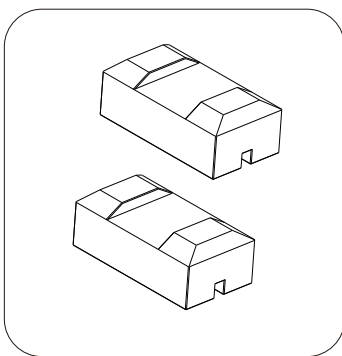

Temp.mount

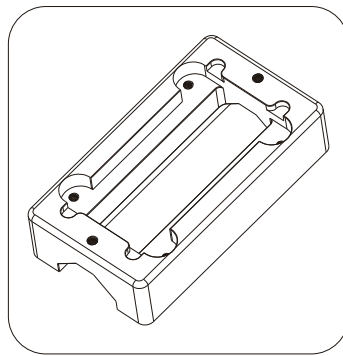

Upper bracket

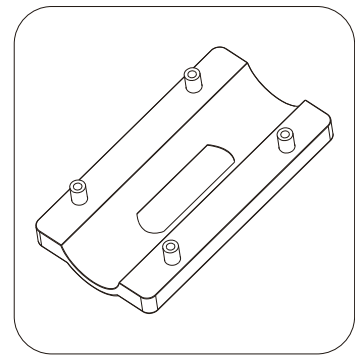

Base bracket

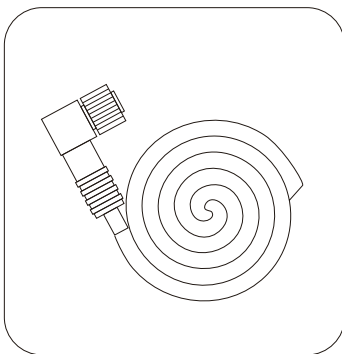

Connecting cables

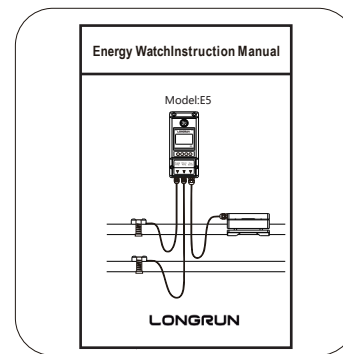

Instruction manual

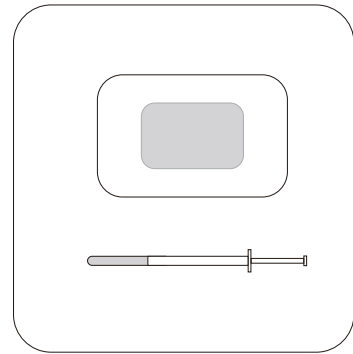

Coupling agent
High temp.silicone

Installation and connection

E5 need to install flow sensor and temperature sensor, clean the pipeline before installation.

Make sure no dirt, paint, or other stains on the surface of the tube. Then put the bottom parts on the side of the pipe.

Step1:Align the bracket to the pipe position; Install screw on top part of the bracket, the bottom part of the bracket will automatically connect with the top part. Tighten the four M4 screws.

Step2: Take the cover off the Flow Transducer. put it into Upper bracket, and tighten two M4 screws.

Step3: Install inlet and outlet temperature sensor. Fix it mount to the pipe and then use high temp. silicon grease on the pipe contact surface, loaded temperature sensor and tighten screw.

Step4: Fix the E5 Unit, where it is easy to observe and where power is available.

Step5: Take out the cable and screw the end of the plug into the socket of E5. It can be easily plugged into the socket in the right direction and then rotated in. Finally connected to the DC power supply, the Energy meter began to measure.

brown +24VDC
 black GND
 blue RS485 A
 white RS485 B

When the E5 is installed, the Energy meter is wired. Connect the DC power and RS485 output.

Panel function

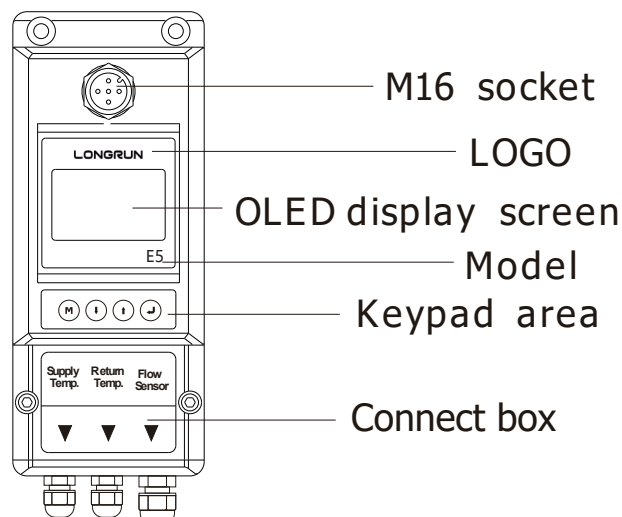

Powering on

As soon as the Flow meter is switched on, the self-diagnosis program will start to run.

SQ 88	12:30:29
Eq 135.28	GJ/H
EH 335.66	GJ
EC 35487.53	GJ

Signal Quality (SQ value)

Q value is short for Signal Quality. It indicates the level of the signal detected. Q value is indicated by numbers from 0~99 represents the minimum signal detected while 99 represent the maximum.

Normally, the transducer position should be adjusted repeatedly and coupling compound should be checked frequently until the signal quality detected is as strong as possible.

Keypad functions

Follow these guide lines when using the Flow meter keypad:

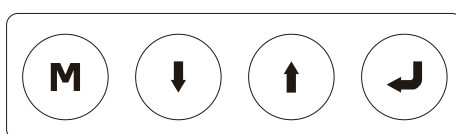

Ⓜ Setting or display mode, when it is setting mode, that can return to the previous menu, ↓ and ↑ scroll up and down to select the menu, when press ↓ move to next digit, press ↑ and the numbers scroll from 0 to 9, you can select the number. Press ↵ to confirm.

Window descriptions

Display Menu

- When the power on, the meter will display Velocity/Net Totalize.

SQ 88	12:30:29
Eq 135.28	GJ/H
EH 335.66	GJ
EC 35487.53	GJ

Display signal quality (SQ), time, heat power (Eq), heat totalizer (EH), cold totalizer (EC)

- Press  will display T1, T2, delta T, press  will return to previous menu.

19-06-22	12:30:29
T1	11.38 C
T2	5.55 C
DT	5.832 K

Display date, time, outlet temp. (T1), inlet temp. (T2), Delta temp. (DT)

- Press  will display Eq, EH, press  will return to previous menu.

SQ 88	12:30:29
12.933	GJ/H
EH 354.53	GJ

Display signal quality (SQ), time, Heat power (GJ/h), Heat totalizer (EH)

- Press  will display Eq, EC, press  will return to previous menu.



SQ 88	12:30:29
95.651	GJ/H
EC 354.53	GJ

Display signal quality (SQ), time, heat power (Eq), cold totalizer (EC)

- Press  will display Flow rate, Net totalizer, press  will return to previous menu.

SQ 88	12:30:29
11.651	m ³ /h
Net 354.53	m ³

Display signal quality (SQ), time, flow rate, Net totalizer

- Press  will display the Unit runtime, press  will return to previous menu.

Runtime	23 h
EHM	5.543 Kwh
ECM	7.248 Kwh
ETM	9.539 m ³

Display Unit runtime, monthly heat totalizer (EHM), monthly energy totalizer (ECM), monthly flow totalizer (ETM)

Setup Menu

Press **M** will display Setup menu.

Setup menu
0.Pipe parameter
1.System setting
2.Calibration

The following options are available (by  or  buttons)





0. Outer diameter
1. System setting
2. Calibration
3. Output setting
4. Energy setting
5. History Data

Setup Menu – Pipe parameter



Press  Select 0.Pipe parameter, then  display:

Pipe parameter
0.Outer diameter
1.Wall thickness
2.Material

The following options are available (by  or  buttons)









0. Outer diameter
1. Wall thickness
2. Material: Move  or  can option PVC, Carbon steel, Steel, Copper pipe.
3. Fluid type: Move  or  can option Water, Sea Water, Oil...etc.

Setup Menu – System setting

Press , Select 1.System setting, then  display:

System setting
0.System Unit
1.Flow rate unit
2.Total unit

The following options are available (by  or  buttons)

- 0.System unit: Move  or  can option Metric, English.
- 1.Flow rate unit: Move  or  can option m³/h, LPM, GPM.
- 2.Total unit: Move  or  can m³, L, GAL.
- 3.Totalize RESET: All parameters are reset, Press , move  or  arrow to select "YES" or "NO". After "YES" is selected.

4. Time set

```
yy-mm-dd hh:mm
19-06-20 12:30
```

Generally, it is unnecessary to modify date time as the system is provided with a highly reliable perpetual calendar chip.

5. System lock

System lock System unlocked	System lock ENT to lock	ENT key word 0000	System lock System locked OK
System lock System locked	System lock ENT to unlock	ENT key word 0000	System lock System unlocked OK

Once the system is locked, any modifications to the system are prohibited, but the parameter is readable. "Unlock" using your designated password. The password is composed of 1 to 4 numbers.



6. System INFO

System INFO EX3 Engery meter SN:EX30001356 V1.02	Manual Totalizer ENT To Start	Manual Totalizar ENT To Stop 1.239 m3/h SQ 88 1.056L	Manual Totalizer ENT TO Restart 1.239 m3/h SQ 88 1.056L
---	----------------------------------	---	--

System INFO: Display serial number (SN) of the meter. This SN is the only one assigned to each flow meter ready to leave the factory.

The factory uses it for files setup and for management by the user.

Set zero: Press ; reset "Zero Point" which was set by the user.

Manual Totalizer: The manual totalize is a separate totalize. Press  to start, and press  to stop it. It is used for flow measurement and calculation.

7. Display dir

```
Display dir
0.Normal
1.Inversion
```

Can choose the direction of display, convenient to observe the measurement data.

Setup Menu – Calibration

Press  , Select 2.Calibration, and then  display:

Calibration
0.Scale factor
1.Set zero
2. Low flow cut

0. Scale factor

Scale factor
1.000

Refers to the ratio between "actual value" and "reading value". For example, when the measurement is 2.00, and it is indicated at 1.98 on the instrument, the scale factor reading is $2/1.98$. This means that the best scale factor constant is 1.01.

1. Set zero: Press  ; reset "Zero Point" which was set by the user.

Set zero
Ent To set zero
Reset zero

Set zero
Waiting...
SQ 88
Vel 0.035 m/s

2. Lowflow cut: Flow rate falls below the low flow cutoff value.

Low flow cut
0.030 m/s

The flow indication is driven to zero. This function can prevent the flow meter from reading flow after a pump is shut down but there is still liquid movement in the pipe, which will result in totalization error. Generally, 0.03m/s is recommended to enter as the low flow cut off point. The low flow cutoff value has no relation to the results once the velocity increases over the low flow cutoff value.

3.Manual zero

ManualZero
0.000 m³/h

The seldom used calibration method is suitable for experienced operators to artificially input an offset superimposed on the measured value in order to obtain the true value when other calibration methods cannot be used well.

For example: Actual measured value =250 m³/h

The offset value =10 m³/h

Meter display =240 m³/h

In general, this value should be set: "0" .

Setup Menu – Output



Press  , Select 3.Output setting, and then  display:

Output setting
0.RS485 Setup
1.Alarm value

0. RS485 setup

RS485 Setup
0.Network addr
1.RS458 Baudrate

The window used to set serial port. Its connection with the equipment of its serial port set of parameters must match.

Move  or  can option baud rate: 2400, 4800, 9600, 19200.

Data length fixed: 8 ;Stop bit for: 1.

Factory serial port parameters for the default "9600, 8, None, 1".

1. Alarm value(Option)

Alarm value
0.Low value
1.High value



Enter the low alarm value; any of the measured flow, which is lower than the low value, will activate the alarm in the OCT hardware or relay output signal.

Enter the high alarm value; any of the measured flow, which is higher than the high value, will activate the alarm in the OCT hardware or relay output signal.

Setup Menu – Energy setting

Press  , Select 4.Energy Setting, and then  display:

Energy setting
0.Energy unit
1.Temp. unit
2.Flow position

The following options are available (by  or  buttons)

0.Energy unit: Move  or  can option: GJ, MBtu, KWh, MWh.

1. Temp unit: Move  or  can option: C or F

2. Flow position: Move  or  can option: Inlet, Outlet

3. DT sensitivity: Move  or  ,You can change the value

4.RTD Calib: Temperature sensor calibration

RTD Caliration
0.T1 K factor
1.T2 K factor

T1 K factor
0.998

T2 K factor
0.998

Setup Menu – History Data

Press  , Select 5.History Data, and then  display:

Date history
0.By Day
1.By Month
2.By Year

0. By Day

Display: Daily heat totalizer (EHD), Daily cold totalizer(ECD), Daily Flow totalizer (ETD)

Day	00-20-08-18
EHD	3.188
ECD	6.889 KWh
FTD	6.866 m3

1. By Month

Display: Monthly heat totalizer(EHM), Monthkt cold totalizer(ECM), Monthly Flow totalizer (ETM)

Month	00-20-08-18
EHM	9.188
ECM	9.889 KWh
FTM	9.866 m3

2. By Year

Display: Year heat totalizer(EHY), Year cold totalizer(ECY), Year Flow totalizer (ETM)

Year	00-20-08-18
EHY	88.196
ECY	96.889 KWh
FTY	89.866 m3

Dimensions

Model	A (mm)	B (mm)	C (mm)	D(mm)	
				min	max
E5-Φ15	25	8	58	1/Φ16.5	7.5/Φ23
E5-Φ20	25	15	58	1/Φ25	4/Φ28
E5-Φ25	28.5	18.5	58	1/Φ32	4/Φ35
E5-Φ32	29.5	24	68	1/Φ38	9/Φ45
E5-Φ40	36	27	78	1/Φ48	7/Φ54
E5-Φ50	41	32	91	1.5/Φ58	8.5/Φ64
E5-Φ65	46.5	40	105	1/Φ72	7/Φ78
E5-Φ80	51.5	43	119	1/Φ80	13/Φ92

E5 Unit dimensions

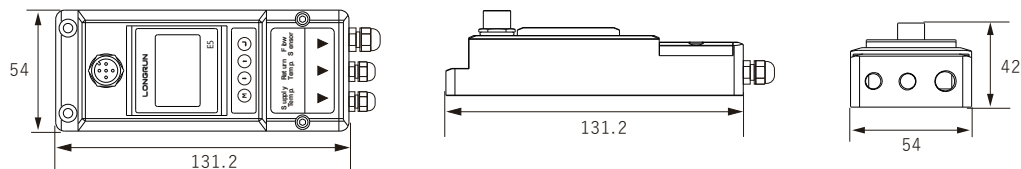

Flow transducer dimensions

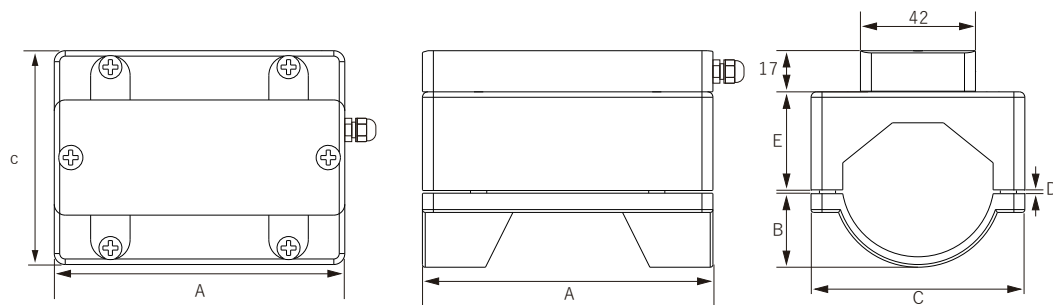

Temp. sensor dimensions

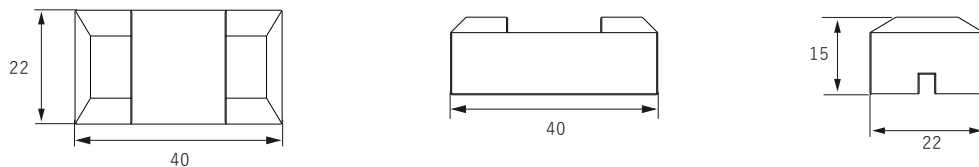

LONGRUN INDUSTRIAL INSTUMENT CO.,LTD

24 hours service: +86-186-5435-6933

Tel:-86-543-3382666

Fax:-86-543-3615999

E-mail:info@ultrasonicscn.com

Skype:Longruncn

Website:www.longrun-flowmeter.com

Add:NO.701,Huanghe ShiEr lu,Binzhou,Shandong province,China

P.C:256600
